

HTB 薄型油壓缸



Hydraulic thin-type Cylinder

• Bore: $\phi 20$ - $\phi 80$ mm • Pmax: 140kg/cm²

產品簡介

- 體積小，節省空間，安裝空間受限制的最佳選擇。
- 標準化規格，直接安裝，不需其它配件，降低成本。
- 缸體材質採用機械構造用炭素鋼，內壁特殊加工處理，表面光滑，使用壽命長。
- 軸向，側向油路板型，免配管提升整體美觀。

Product Introduction

- Compact construction for space saving. Ideal for application in a restricted space.
- Standardized specifications. Direct installation without need of any further accessories for saving cost.
- The cylinder barrel is manufactured from structural carbon steel. Internal wall is specially treated, featuring maximum smoothness and long service life.
- Axial and side manifold type eliminate the use of piping for upgrading appearance elegance.

傳統油缸與薄型缸總長度之比較
A comparison of length between the traditional hydraulic cylinder and thin type cylinder.

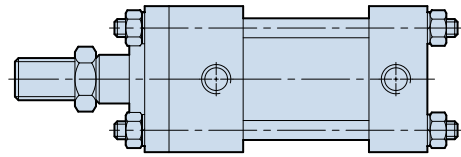
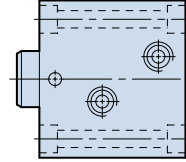

特性資料 Specifications

安裝型式 Installation	軸向 Axial 側向 Side	SD單軸; SW雙軸 LA單軸; LW雙軸
操作壓力範圍 Operation pressure range	5-140 kg/cm ²	
使用速度範圍 Operation speed range	8-100 mm/sec	
使用溫度範圍 Operation temperature range	-10~+60°C	
使用流體 Fluid	已濾清之標準液壓油 Filtered hydraulic oil	
作動方式 Acting type	複動式 Double acting	
油缸本體材質 Material of cylinder barrel	炭素鋼 Carbon steel	

理論出力表 Clamping force

F1: 推出 Push out ←

F2: 拉入 Pull in →

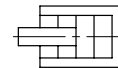

UNIT: Kg

油缸內徑 Bore of cylinder (mm)	活塞桿徑 Piston-rod (mm)	受壓面積 Pressure area(cm ²)		操作壓力 Operation pressure(kg/cm ²)									
				10		35		70		100		140	
		F1	F2	F1	F2	F1	F2	F1	F2	F1	F2	F1	F2
$\phi 20$	$\phi 12$	3.14	2.01	31	20	110	71	220	141	314	201	440	281
$\phi 25$	$\phi 14$	4.91	3.37	49	34	172	118	344	236	491	337	687	472
$\phi 32$	$\phi 20$	8.04	4.9	80	49	281	172	563	343	804	490	1126	686
$\phi 40$	$\phi 25$	12.57	7.66	126	77	440	268	880	536	1257	766	1760	1072
$\phi 50$	$\phi 30$	19.63	12.56	196	126	687	440	1374	879	1963	1256	2748	1758
$\phi 63$	$\phi 35$	31.17	21.55	312	216	1091	754	2182	1509	3117	2155	4364	3017
$\phi 80$	$\phi 45$	50.27	34.37	503	344	1759	1203	3519	2406	5027	3437	7038	4812

HTB 薄型油壓缸



Hydraulic thin-type Cylinder

• Bore: $\phi 20$ - $\phi 80$ mm • Pmax: 140kg/cm²

SD 軸向安裝型(單軸) $\phi 20$ - $\phi 80$
SD Axial Mounting Type (Single End Rod)

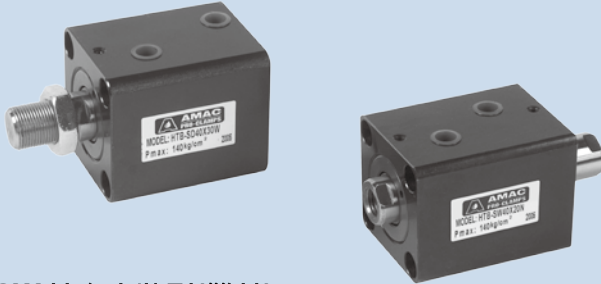

SW 軸向安裝型(雙軸) $\phi 20$ - $\phi 80$
SW Axial Mounting Type (Double End Rod)

LA 側向安裝型(單軸) $\phi 20$ - $\phi 63$
LA Side Mounting Type (Single End Rod)

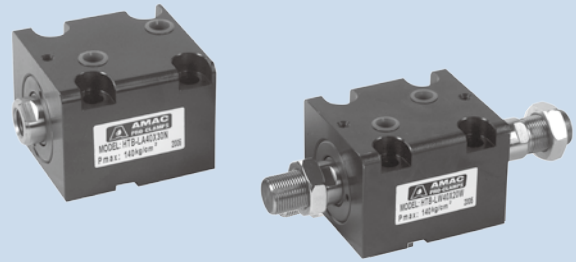

LW 側向安裝型(雙軸) $\phi 20$ - $\phi 63$
LW Side Mounting Type (Double End Rod)

SDMA 軸向前油路板型 $\phi 20$ - $\phi 80$
SDMA Axial Front Manifold Type

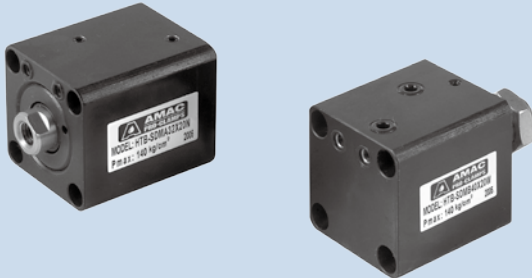

SDMB 軸向後油路板型 $\phi 20$ - $\phi 80$
SDMB Axial Back manifold Type

LAM 側向油路板型(單軸) $\phi 20$ - $\phi 63$
LAM Side Manifold Type (Single End Rod)



LWM 側向油路板型(雙軸) $\phi 20$ - $\phi 63$
LWM Side manifold Type (Double End Rod)

HTM 薄型感應油壓缸 $\phi 32$ - $\phi 80$
HTM Magnetic-type hydraulic cylinder
行程規格參考訂購標示法
Refer to ordering code for stroke specifications



HTM70
Pmax: 70 kg/cm²

HTM140
Pmax: 140 kg/cm²

軸端型式接受訂製, 訂購時請提供尺寸 $\phi 20$ - $\phi 80$
Custom rod end type is available. Provide your desired sizes when ordering.



行程規格表 Stroke specifications

註: 記號 \odot 之油缸本體長度須加長 5mm

NOTE: Sizes marked with \odot should add 5mm to cylinder body length.

TYPE BORE	SD SDMA SDMB							SW							LA LAM							LW LWM						
	$\phi 20$	$\phi 25$	$\phi 32$	$\phi 40$	$\phi 50$	$\phi 63$	$\phi 80$	$\phi 20$	$\phi 25$	$\phi 32$	$\phi 40$	$\phi 50$	$\phi 63$	$\phi 80$	$\phi 20$	$\phi 25$	$\phi 32$	$\phi 40$	$\phi 50$	$\phi 63$	$\phi 20$	$\phi 25$	$\phi 32$	$\phi 40$	$\phi 50$	$\phi 63$		
5	\odot	\odot	●	●	●	●	●	\odot	\odot	\odot	\odot	\odot	\odot	\odot	\odot	\odot	\odot	\odot	\odot	\odot	\odot	\odot	\odot	\odot	\odot	\odot	\odot	
10	●	●	●	●	●	●	●	●	●	●	●	●	●	●	●	●	●	●	●	●	●	●	●	●	●	●	●	●
15	\odot	\odot	●	●	●	●	●	\odot	\odot	\odot	\odot	\odot	\odot	\odot	\odot	\odot	\odot	\odot	\odot	\odot	\odot	\odot	\odot	\odot	\odot	\odot	\odot	
20	●	●	●	●	●	●	●	●	●	●	●	●	●	●	●	●	●	●	●	●	●	●	●	●	●	●	●	●
25	\odot	\odot	●	●	●	●	●	\odot	\odot	\odot	\odot	\odot	\odot	\odot	\odot	\odot	\odot	\odot	\odot	\odot	\odot	\odot	\odot	\odot	\odot	\odot	\odot	
30	●	●	●	●	●	●	●	●	●	●	●	●	●	●	●	●	●	●	●	●	●	●	●	●	●	●	●	●
40	●	●	●	●	●	●	●	X	●	●	●	●	●	●	●	●	●	●	●	●	●	X	●	●	●	●	●	●
50	X	●	●	●	●	●	●	X	X	●	●	●	●	●	X	●	●	●	●	●	X	X	●	●	●	●	●	

HTB 薄型油壓缸 SD. SW



Hydraulic thin-type Cylinder SD.SW

• Bore: $\phi 20$ - $\phi 80$ mm • Pmax: 140kg/cm²

訂購標示法 Ordering Code

HTB - **SD** **32** × **20** **N**

↑ ↑ ↑ ↑ ↑

① ② ③ ④ ⑤

①	系列別 Series	HTB	
②	安裝型式 Mounting type	SD	軸向單軸型 Single end rod type
		SW	軸向雙軸型 Double end rod type
③	油缸內徑 Bore of cylinder	$\phi 20, \phi 25, \phi 32, \phi 40, \phi 50, \phi 63, \phi 80$	
④	標準行程 Standard stroke	請參考行程規格表 Please refer to the stroke specification	
⑤	軸端型式 Rod end type	內牙N: Internal thread N	
		外牙W: External thread W	

SD-N

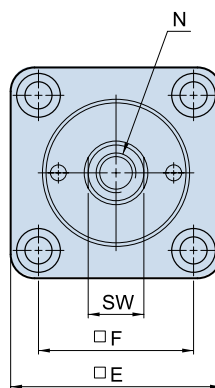
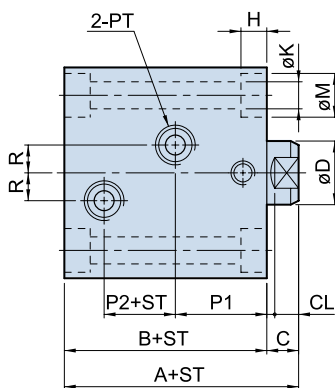

SD-W

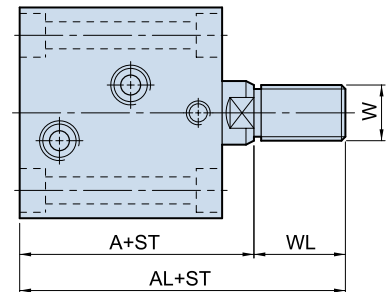

SW-N

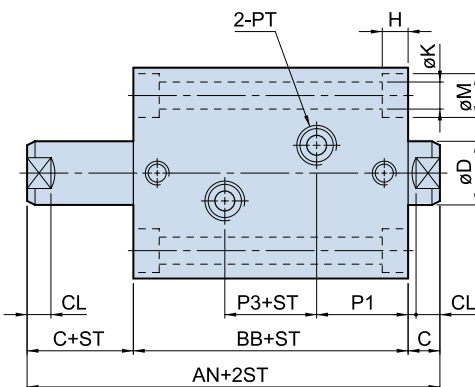

SW-W

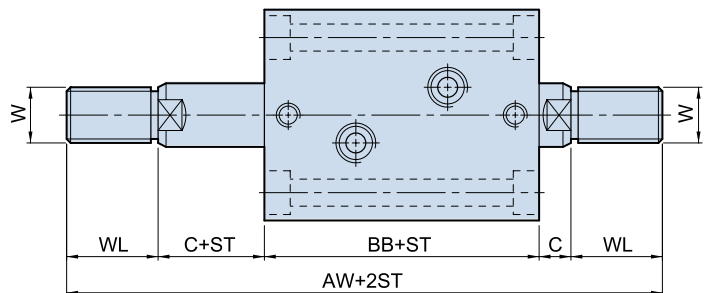

ST=Stroke

Dimensional table

$\phi 20, \phi 25$ 右列行程之本體長度B尺寸相同 (5,10) (15,20) (25,30)

$\phi 20, \phi 25$ The length "B" of cylinder body is the same of the stroke: (5,10) (15,20) (25,30)

UNIT:mm

Bore	A	AL	AN	AW	B	BB	C	CL	D	SW	E	F	H	K	M	N	W	WL	P1	P2	P3	R	PT
$\phi 20$	51	71	72	112	43	56	8	6	12	10	42	30	5.5	5.6	9	M8x1.25x12D.	M10x1.25	20	22.5	11	11	5	1/8
$\phi 25$	53	75	74	118	45	58	8	6	14	12	48	36	5.5	5.6	9	M10x1.5x15D.	M12x1.25	22	23	12	12	7	1/8
$\phi 32$	64	89	89	139	54	69	10	7	20	17	62	47	6.5	6.8	11	M12x1.75x15D.	M16x1.5	25	28	14	13	10	1/4
$\phi 40$	65	95	90	150	55	70	10	7	25	22	70	52	9	9	14	M16x2.0x20D.	M22x1.5	30	28	15	14	10	1/4
$\phi 50$	71	106	97	167	60	75	11	8	30	27	80	58	11	11	18	M20x2.5x25D.	M26x1.5	35	29.5	18	16	10	1/4
$\phi 63$	80	120	108	188	67	82	13	10	35	32	94	69	13	13	20	M27x3.0x35D.	M30x1.5	40	31	20	20	10	3/8
$\phi 80$	95	140	127	217	78	93	17	14	45	41	114	86	15	15	22	M30x3.5x35D.	M39x1.5	45	33	27	27	15	3/8

HTB 油路板型油壓缸 SDMA. SDMB



Manifold Type Hydraulic Cylinder SDMA.SDMB

• Bore: $\phi 20$ - $\phi 80$ mm • Pmax: 140kg/cm²

訂購標示法 Ordering Code

HTB - **SDMA** **32** × **20** **N**

↑ ↑ ↑ ↑ ↑

① ② ③ ④ ⑤

①	系列別 Series	HTB		
②	安裝型式 Mounting type	SDMA	軸向前油路板型	Axial front manifold type
		SDMB	軸向後油路板型	Axial back manifold type
③	油缸內徑 Bore of cylinder	$\phi 20$. $\phi 25$. $\phi 32$. $\phi 40$. $\phi 50$. $\phi 63$. $\phi 80$		
④	標準行程 Standard stroke	請參考行程規格表 Please refer to the stroke specification		
⑤	軸端型式 Rod end type	內牙N: Internal thread N 外牙W: External thread W		

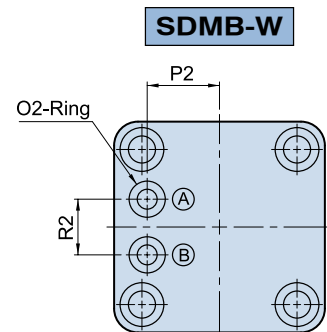
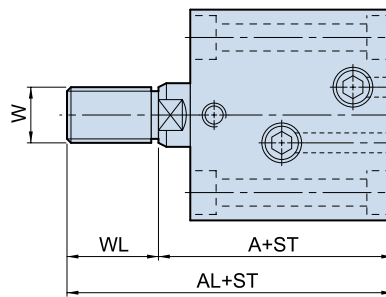
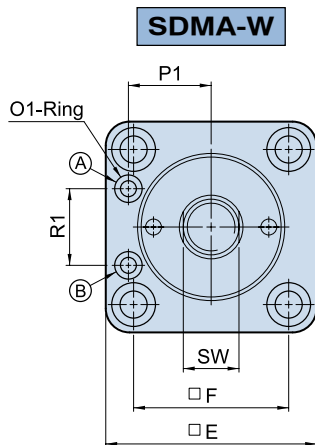
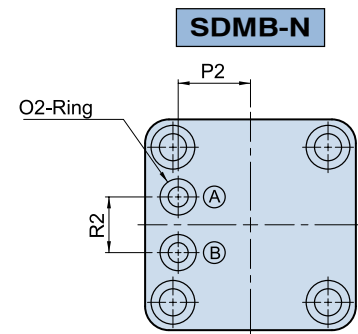
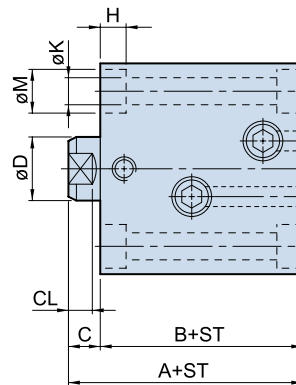
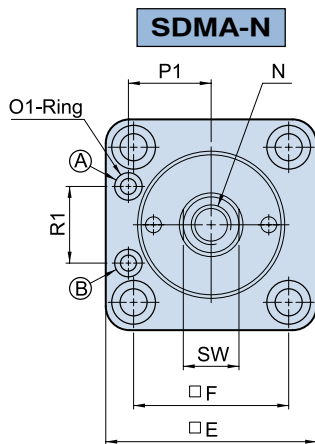

ST=Stroke

(A)	推出油孔 Push out
(B)	拉入油孔 Pull in

Dimensional table

$\phi 20, \phi 25$ 右列行程之本體長度B尺寸相同 (5,10) (15,20) (25,30)

$\phi 20, \phi 25$ The length "B" of cylinder body is the same of the stroke: (5,10) (15,20) (25,30)

UNIT:mm

Bore	A	AL	B	C	CL	D	SW	E	F	H	K	M	N	W	WL	SDMA			SDMB		
																P1	R1	O1	P2	R2	O2
$\phi 20$	51	71	43	8	6	12	10	42	30	5.5	5.6	9	M8x1.25x12D.	M10x1.25	20	16.5	13	P4	13	11	P5
$\phi 25$	53	75	45	8	6	14	12	48	36	5.5	5.6	9	M10x1.5x15D.	M12x1.25	22	19.5	18	P4	16	13	P7
$\phi 32$	64	89	54	10	7	20	17	62	47	6.5	6.8	11	M12x1.75x15D.	M16x1.5	25	24	24	P6	20	20	P9
$\phi 40$	65	95	55	10	7	25	22	70	52	9	9	14	M16x2.0x20D.	M22x1.5	30	27	26	P6	24	20	P9
$\phi 50$	71	106	60	11	8	30	27	80	58	11	11	18	M20x2.5x25D.	M26x1.5	35	32	27	P8	29	20	P9
$\phi 63$	80	120	67	13	10	35	32	94	69	13	13	20	M27x3.0x35D.	M30x1.5	40	38	35	P8	35	26	P11
$\phi 80$	95	140	78	17	14	45	41	114	86	15	15	22	M30x3.5x35D.	M39x1.5	45	47	45	P11	44	30	P11

HTB 薄型油壓缸 LA.LW



Hydraulic Thin-Type Cylinder LA.LW

• Bore: $\phi 32$ - $\phi 63$ mm • Pmax: 140kg/cm²

訂購標示法 Ordering Code

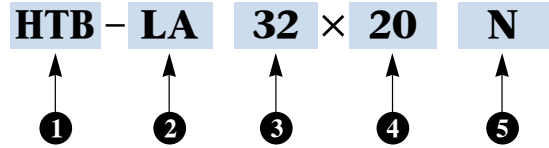

①	系列別 Series	HTB	
②	安裝型式 Mounting type	LA	側向單軸型 Single end rod type
		LW	側向雙軸型 Double end rod type
③	油缸內徑 Bore of cylinder	$\phi 32, \phi 40, \phi 50, \phi 63$.	
④	標準行程 Standard stroke	10. 20. 30. 40. 50	
⑤	軸端型式 Rod end type	內牙N: Internal thread N 外牙W: External thread W	

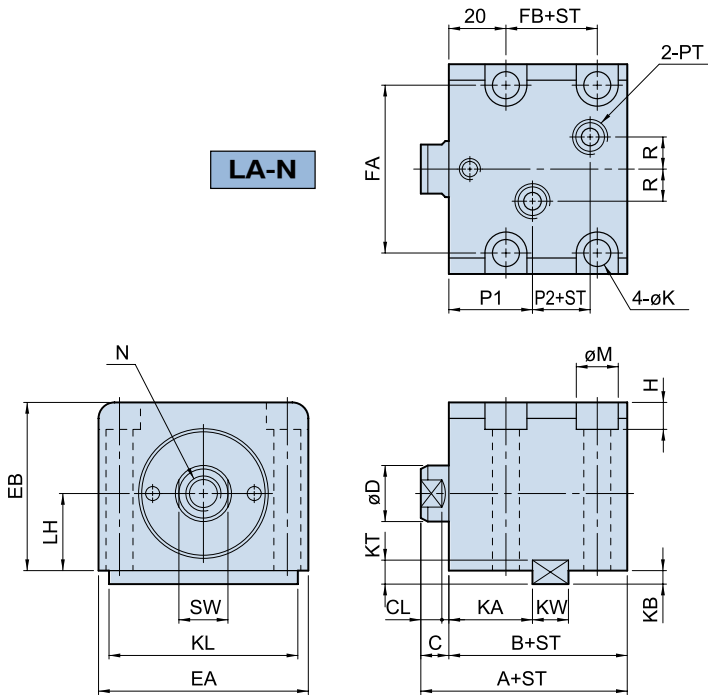

LW-N

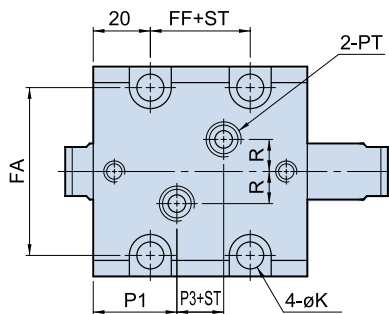

LA-W

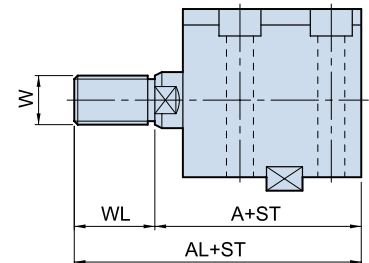

LW-W

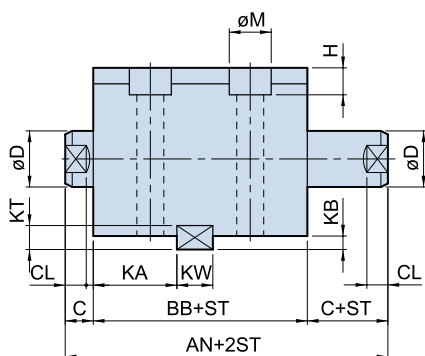
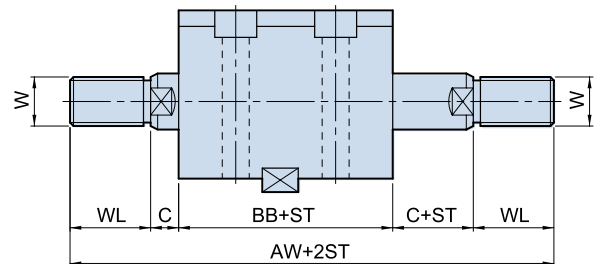

KEY



Key size

UNIT:mm

Bore	KW	KT	KL	KA	KB
$\phi 32$	12	8	63	28	4.5
$\phi 40$	12	8	70	28	4.5
$\phi 50$	14	9	80	29	5
$\phi 63$	16	10	100	31	5.5

ST=Stroke

Dimensional table

右列行程之本體長度B及BB尺寸相同 (5,10) (15,20) (25,30) (35,40) (45,50)
The length "B" and "BB" of cylinder body is the same of the stroke: (5,10) (15,20) (25,30) (35,40) (45,50) UNIT:mm

Bore	A	AL	AN	AW	B	BB	C	CL	D	SW	EA	EB	LH	FA	FB	FF	H	K	M	N	W	WL	P1	P2	P3	R	PT
$\phi 32$	64	89	89	139	54	69	10	7	20	17	70	56	25	56	24	32	9	9	14	M12x1.75x15D.	M16x1.5	25	28	14	13	10	1/4
$\phi 40$	65	95	90	150	55	70	10	7	25	22	80	64	29	62	23	32	11	11	18	M16x2.0x20D.	M22x1.5	30	28	15	14	10	1/4
$\phi 50$	71	106	97	167	60	75	11	8	30	27	94	74	34	74	27	35	13	13	20	M20x2.5x25D.	M26x1.5	35	29.5	18	16	10	1/4
$\phi 63$	80	120	108	188	67	82	13	10	35	32	114	89	42	90	32	42	15	15	22	M27x3.0x35D.	M30x1.5	40	31	20	20	10	3/8

HTB 油路板型油壓缸 LAM. LWM



Manifold Type Hydraulic Cylinder LAM.LWM

• Bore: $\phi 32$ - $\phi 63$ mm • Pmax: 140kg/cm²

訂購標示法 Ordering Code

HTB - LAM 32 × 20 N



1	系列別 Series	HTB
2	安裝型式 Mounting type	LAM 側向單軸型 Single end rod type LWM 側向雙軸型 Double end rod type
3	油缸內徑 Bore of cylinder	$\phi 32, \phi 40, \phi 50, \phi 63$
4	標準行程 Standard stroke	10, 20, 30, 40, 50
5	軸端型式 Rod end type	內牙N: Internal thread N 外牙W: External thread W

註:行程10mm無附鍵槽及平鍵。
Stroke: 10mm without key.

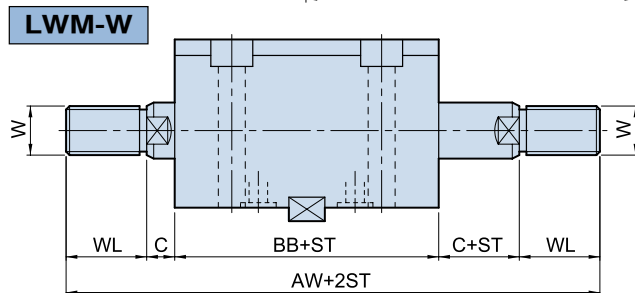
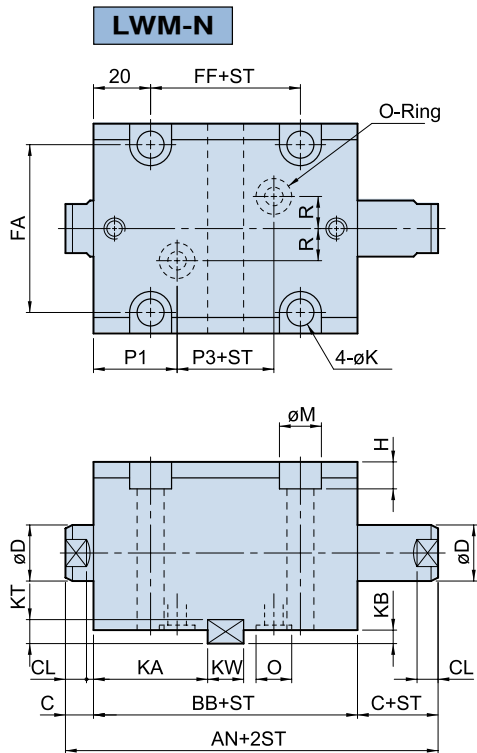
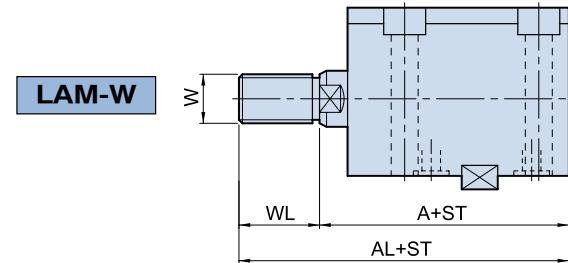
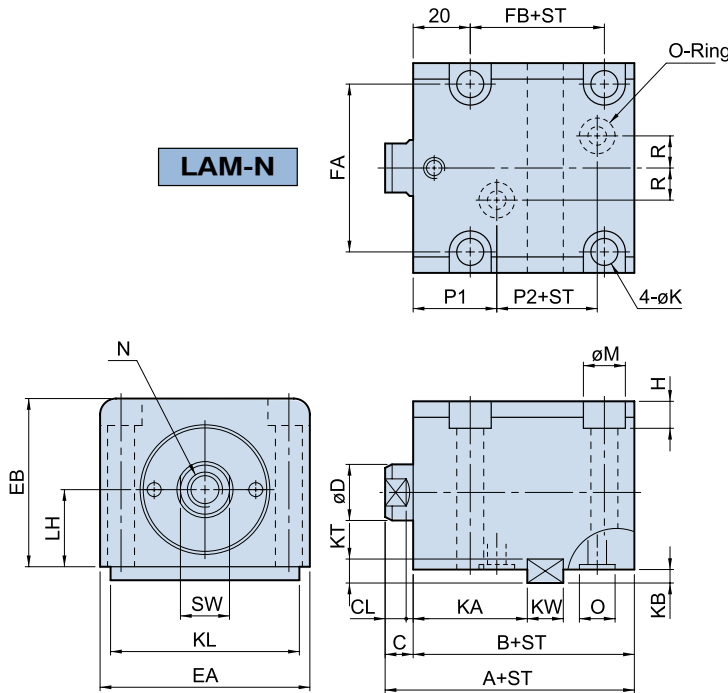

KEY



Key size

UNIT:mm

Bore	KW	KT	KL	KA	KB
$\phi 32$	12	8	63	38	4.5
$\phi 40$	12	8	70	38	4.5
$\phi 50$	14	9	80	40	5
$\phi 63$	16	10	100	42	5.5

ST=Stroke

Dimensional table

右列行程之本體長度B及BB尺寸相同 (5, 10)(15, 20)(25, 30)(35, 40)(45, 50)
The length "B" and "BB" of cylinder body is the same of the stroke: (5, 10)(15, 20) (25, 30) (35, 40) (45, 50)

UNIT:mm

Bore	A	AL	AN	AW	B	BB	C	CL	D	SW	EA	EB	LH	FA	FB	FF	H	K	M	N	W	WL	P1	P2	P3	R	O
$\phi 32$	64	89	89	139	54	69	10	7	20	17	70	56	25	56	24	32	9	9	14	M12x1.75x15D.	M16x1.5	25	28	14	13	10	P9
$\phi 40$	65	95	90	150	55	70	10	7	25	22	80	64	29	62	23	32	11	11	18	M16x2.0x20D.	M22x1.5	30	28	15	14	10	P9
$\phi 50$	71	106	97	167	60	75	11	8	30	27	94	74	34	74	27	35	13	13	20	M20x2.5x25D.	M26x1.5	35	29.5	18	16	10	P11
$\phi 63$	80	120	108	188	67	82	13	10	35	32	114	89	42	90	32	42	15	15	22	M27x3.0x35D.	M30x1.5	40	31	20	20	10	P11

HTB 薄型油壓缸 LA20. LA25



Hydraulic Thin-Type Cylinder

• Bore: $\phi 20$ - $\phi 25$ mm • Pmax: 140kg/cm²

訂購標示法 Ordering Code

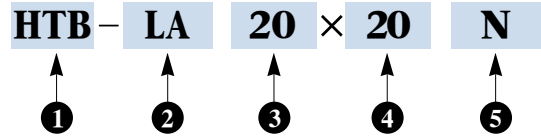

①	系列別 Series	HTB	
②	側向安裝 Side mounting	LA	配管式單軸 Line type (Single end rod)
		LW	配管式雙軸 Line type (Double end rod)
		LAM	油路板單軸 Manifold type (Single end rod)
		LWM	油路板雙軸 Manifold type (Double end rod)
③	油缸內徑 Bore of cylinder	$\phi 20$	$\phi 25$
④	標準行程 Standard stroke	10.20.30.40	10.20.30.40.50
⑤	軸端型式 Rod end type	內牙N: Internal thread N 外牙W: External thread W	

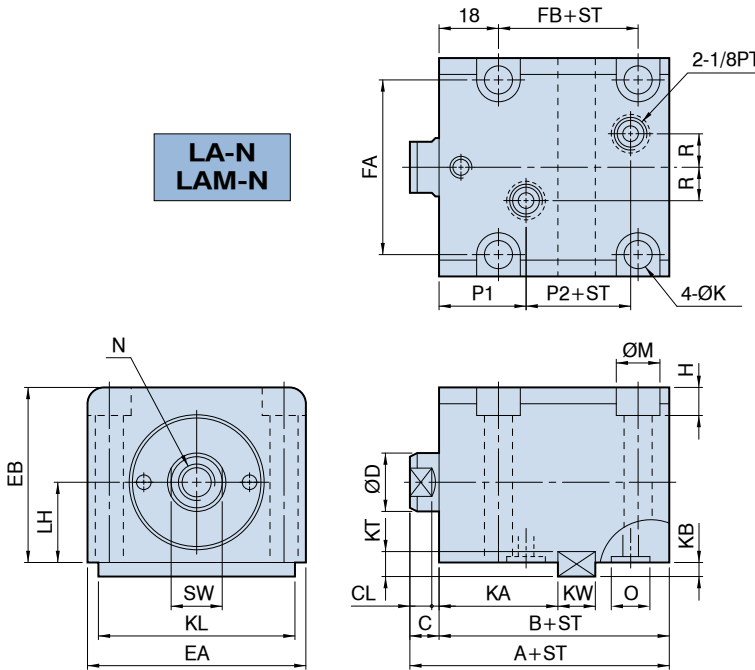

LW-N.LWM-N

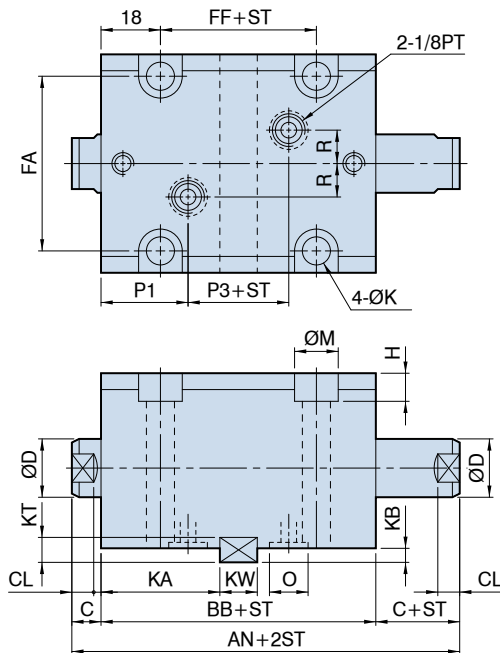

LA-W LAM-W

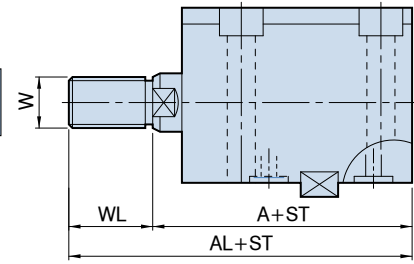

LW-W LWM-W

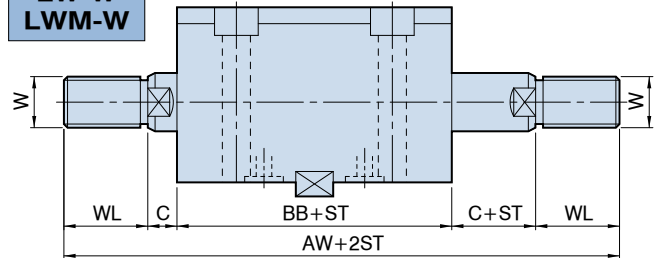

KEY

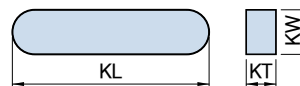

ST=Stroke

Dimensional table

右列行程之本體長度B及BB尺寸相同(5,10)(15,20)(25,30)(35,40)(45,50)
The length "B" and "BB" of cylinder body is the same of the stroke:(5,10)(15,20)(25,30)(35,40)(45,50)

UNIT:mm

Bore	A	AL	AN	AW	B	BB	C	CL	D	SW	EA	EB	LH	FA	FB	FF	H
Ø20	51	71	72	112	43	56	8	6	12	10	46	37	16	35	16	20	6.5
Ø25	53	75	74	118	45	58	8	6	14	12	52	44	20	41	18	22	6.5
Bore	K	M	N	W	WL	P1	P2	P3	R	O	KW	KT	KL	KA	KB		
Ø20	6.8	11	M8x1.25x12D.	M10x1.25	20	22.5	11	11	5	P7	8	7	40	29	3.5		
Ø25	6.8	11	M10x1.5x15D.	M12x1.25	22	23	12	12	7	P7	8	7	45	30	3.5		

HTM70 薄型感應油壓缸 SD, SDMB



Magnetic-Type Hydraulic Cylinder SD, SDMB

• Bore: $\phi 32$ - $\phi 80$ mm • Pmax: 70kg/cm²

訂購標示法 Order Code

HTM70 - SD 32 × 20 N - S1

↑ ↑ ↑ ↑ ↑ ↑

① ② ③ ④ ⑤ ⑥

①	系列別 Series	HTM70			
②	安裝型式 Mounting type	SD	標準型	Standard	
		SDMB	油路板型	Manifold type	
③	油缸內徑 Bore of cylinder	$\phi 32, \phi 40, \phi 50, \phi 63, \phi 80$			
④	標準行程 Standard stroke	10, 20, 30, 40, 50			
⑤	軸端型式 Rod end type	內牙N: Internal thread N 外牙W: External thread W			
⑥	近接開關 Sensor switch	S1: 1個 S2: 2個 1Pc of S1, 2Pcs of S2 電壓 Volt: DC4-24V AC4-120V 電流 Current: 5-40mA			

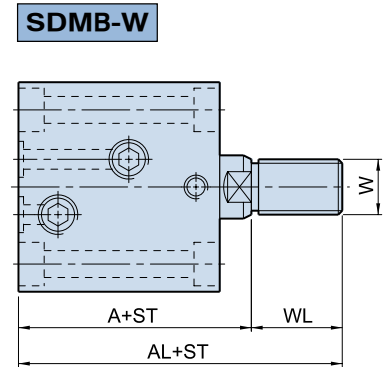
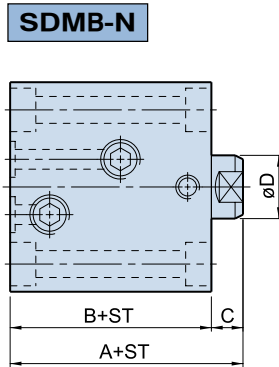
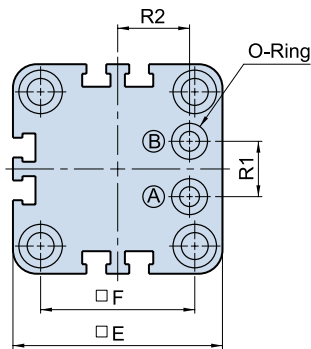
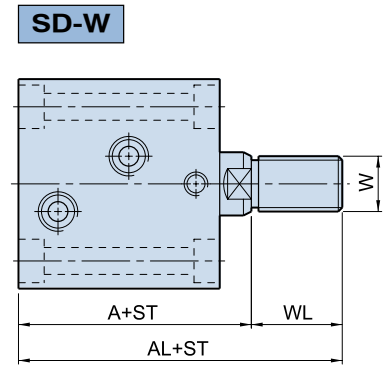
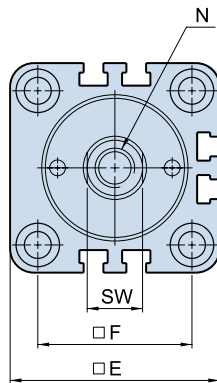
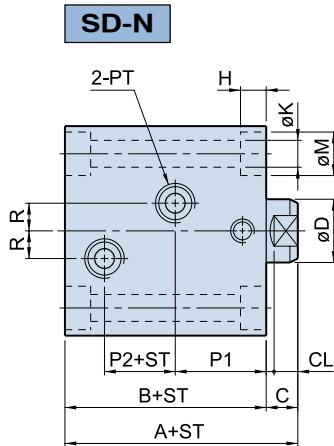

- (A) 推出油孔
Push out
- (B) 拉入油孔
Pull in

ST = Stroke

Dimensional table

右列行程之本體長度B尺寸相同 (5,10) (15,20) (25,30) (35,40) (45,50)

The length "B" of cylinder body is the same of the stroke: (5,10) (15,20) (25,30) (35,40) (45,50)

UNIT:mm

Bore	A	AL	B	C	CL	D	SW	E	F	H	K	M	N	W	WL	SD				SDMB		
																P1	P2	R	PT	R1	R2	O
$\phi 32$	64	89	54	10	7	20	17	62	47	6.5	6.8	11	M12x1.75x15D.	M16x1.5	25	28	14	10	1/4	20	20	P9
$\phi 40$	65	95	55	10	7	25	22	70	52	9	9	14	M16x2.0x20D.	M22x1.5	30	28	15	10	1/4	20	24	P9
$\phi 50$	71	106	60	11	8	30	27	80	58	11	11	18	M20x2.5x25D.	M26x1.5	35	29.5	18	10	1/4	20	29	P9
$\phi 63$	80	120	67	13	10	35	32	94	69	13	13	20	M27x3.0x35D.	M30x1.5	40	31	20	10	3/8	26	35	P11
$\phi 80$	95	140	78	17	14	45	36	114	86	15	15	22	M30x3.5x35D.	M39x1.5	45	33	27	15	3/8	30	44	P11

HTM140 薄型感應油壓缸 SD. SW



Magnetic-Type Hydraulic Cylinder SD. SW

• Bore: $\phi 32$ - $\phi 80$ mm • Pmax: 140kg/cm²

訂購標示法 Order Code

HTM140 - SD 32 × 20 N - S1

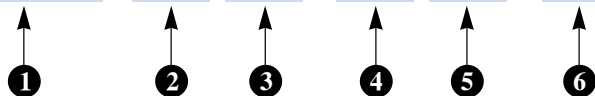

①	系列別 Series	HTM140	
②	安裝型式 Mounting type	SD	軸向單軸型 Single end rod type
		SW	軸向雙軸型 Double end rod type
③	油缸內徑 Bore of cylinder	$\phi 32, \phi 40, \phi 50, \phi 63, \phi 80$	
④	標準行程 Standard stroke	10, 20, 30, 40, 50 (行程標示外 接受訂作) Other stroke available	
⑤	軸端型式 Rod end type	內牙N: Internal thread N 外牙W: External thread W	
⑥	近接開關 Sensor switch	S1:1個 S2:2個 1Pc of S1, 2Pcs of S2 電壓 Volt: DC4-24V AC4-120V 電流 Current: 5-40mA	

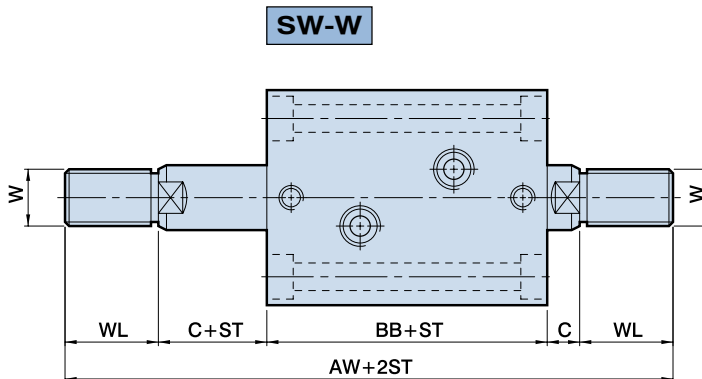
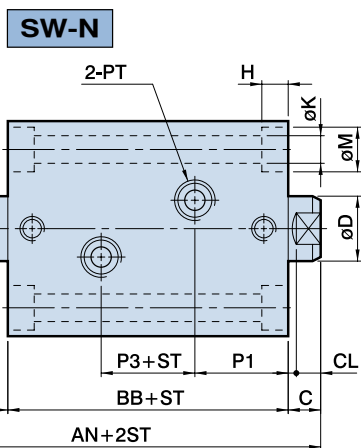
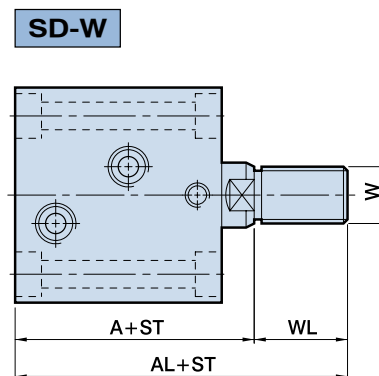
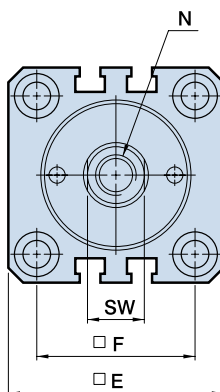
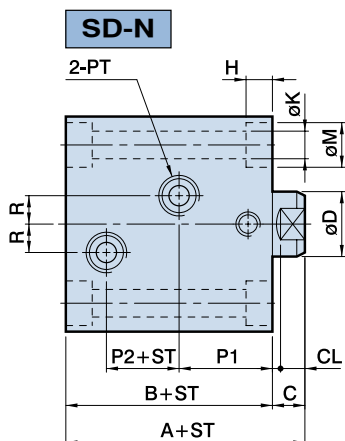

ST=Stroke

Dimensional table

UNIT:mm

Bore	A	AL	AN	AW	B	BB	C	CL	D	SW	E	F	H	K	M	N	W	WL	P1	P2	P3	R	PT
$\phi 32$	83	108	104	154	73	84	10	7	20	17	62	47	6.5	6.8	11	M12x1.75x15D.	M16x1.5	25	27	29	30	10	1/4
$\phi 40$	80	110	101	161	70	81	10	7	25	22	70	52	9	9	14	M16x2.0x20D.	M20x1.5	30	27	27	27	10	1/4
$\phi 50$	86	121	109	179	75	87	11	8	30	27	80	58	11	11	18	M20x2.5x25D.	M24x1.5	35	28	31	31	10	1/4
$\phi 63$	97	142	120	210	84	94	13	10	35	32	94	69	13	13	20	M27x3.0x33D.	M30x1.5	45	30	36	34	10	1/4
$\phi 80$	112	167	140	250	95	106	17	14	40	37	114	86	15	15	22	M30x3.5x33D.	M36x1.5	55	35	38	36	15	3/8